

FINE series PURE®

F900接頭系列

FINELOK·PURE®

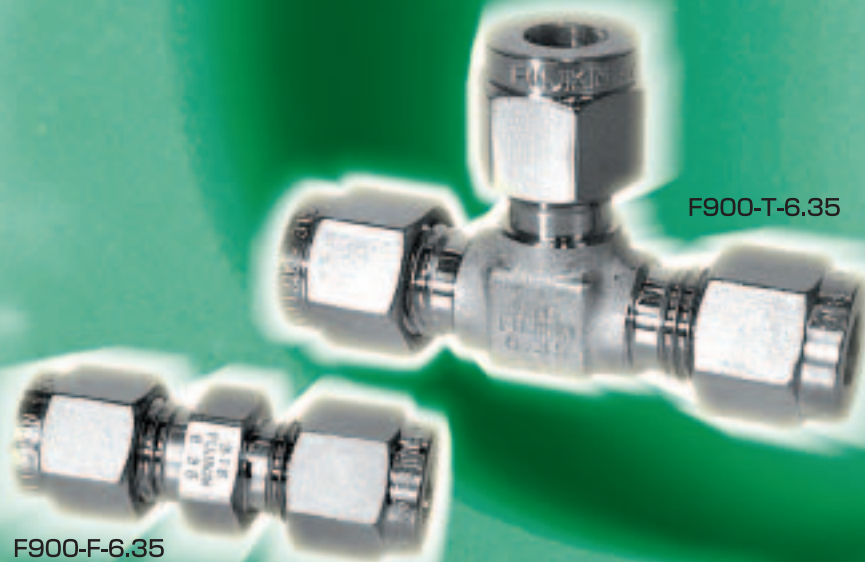

Safety & Clean Technology

富士金集團













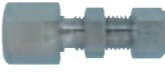



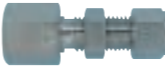









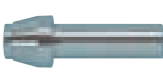



















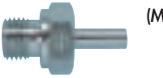

管接頭一覽表

追求「信賴性之極限值」的富士金產品陣容

FINELOK PURE®是精密管接頭業者，經由長年之經驗累積，全力發揮專業設計、生產技術，成功研發並順利達成量產目標，具備卓越性能、優良品質之配管接頭。

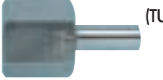
FINELOK PURE®是一款完全不需要在配管上栓螺絲或燃燒(FLARE)加工，即可進行連接的非燃燒類型、高精密技術配管接頭。基本結構由不鏽鋼(SUS316)本體(STAINLESS BODY)、前環(FRONT RING)、後環(BACK RING)與母螺帽(NUT)等4部份所組成。



 半連管接頭(HALF UNION) (R螺絲) 5	 儀錶面板連管接頭 (GAUGE PANEL UNION) (Rc螺絲) 9	 彎管減壓連管接頭 (ELBOW REDUCER UNION) (對口熔接式) 13	 TL 連管接頭 (TL UNION) (NPT螺絲) 16
 半連管接頭(HALF UNION) (NPT螺絲) 5	 儀錶面板連管接頭 (GAUGE PANEL UNION) (NPT螺絲) 9	 T型連管接頭 (T UNION) 13	 連管接頭管帽 (CAP UNION) 17
 熱電偶式半連管接頭 (THERMO COUPLE TYPE HALF UNION) (R螺絲) 6	 減壓連管接頭 (REDUCER UNION) 9	 異徑T型連管接頭 (異徑T UNION) 13	 連管塞 (PLUG UNION) 17
 O型環半連管接頭 (O-RING TYPE HALF UNION) (UNF螺絲) 6	 面板減壓連管接頭 (PANEL REDUCER UNION) 10	 十字型連管接頭 (CROSS UNION) 13	 接埠連接器 (PORT CONNECTOR) 17
 半面板連管接頭 (HALF PANEL UNION) (R螺絲) 6	 減壓連管接頭 (REDUCER UNION) (插入熔接式) 10	 T型儀錶連管接頭 (T GAUGE UNION) (G螺絲) 14	 前環(FRONT RING)、後環(BACK RING) 17
 半面板連管接頭 (HALF PANEL UNION) (NPT螺絲) 7	 減壓連管接頭 (REDUCER UNION) (對口熔接式) 10	 T型儀錶連管接頭 (T GAUGE UNION) (Rc螺絲) 14	 母螺帽 (NUT) 18
 直式連管接頭 (STRAIGHT UNION) 7	 彎管連管接頭 (ELBOW UNION) 10	 T型儀錶連管接頭 (T GAUGE UNION) (NPT螺絲) 14	 配管轉接器 (TUBE ADAPTER) (R螺絲) 18
 異徑直式連管接頭 (異徑STRAIGHT UNION) 7	 彎管半連管接頭 (ELBOW HALF UNION) (R螺絲) 11	 TL 儀錶連管接頭 (TL GAUGE UNION) (Rc螺絲) 15	 配管轉接器 (TUBE ADAPTER) (NPT螺絲) 18
 面板連管接頭 (PANEL UNION) 7	 彎管半連管接頭 (ELBOW HALF UNION) (NPT螺絲) 11	 TL 儀錶連管接頭 (TL GAUGE UNION) (NPT螺絲) 15	 公配管轉接器 (MALE TUBE ADAPTER) (G螺絲) 19
 儀錶連管接頭 (GAUGE UNION) (G螺絲) 8	 彎管儀錶連管接頭 (ELBOW GAUGE UNION) (Rc螺絲) 12	 TS 連管接頭 (TS UNION) (R螺絲) 15	 O型環配管轉接器 (O-RING TYPE TUBE ADAPTER) (UNF螺絲) 19
 儀錶連管接頭 (GAUGE UNION) (Rc螺絲) 8	 彎管儀錶連管接頭 (ELBOW GAUGE UNION) (NPT螺絲) 12	 TS連管接頭 (TS UNION) (NPT螺絲) 16	 配管儀錶轉接器 (TUBE GAUGE ADAPTER) (Rc螺絲) 19
 儀錶連管接頭 (GAUGE UNION) (NPT螺絲) 8	 彎管減壓連管接頭 (ELBOW REDUCER UNION) (插入熔接式) 12	 TL 連管接頭 (TL UNION) (R螺絲) 16	 配管儀錶轉接器 (TUBE GAUGE ADAPTER) (NPT螺絲) 20

Safety & Clean Technology



特徵

本體上標示著配管尺寸，透過目測方式，即可確認尺寸。

本體氣密部位經過超精密技術加工。雖然為金屬方式，卻可達到超高氣密效果。

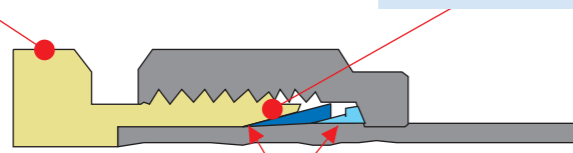

採用獨特的雙環連動作動方式，前、後環有效的塑性變形使得配管經強力壓縮後達到非常卓越之耐用性。

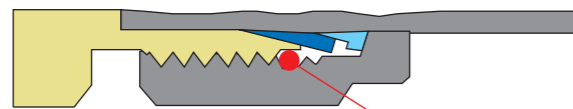

母螺帽的螺紋部位經過銀電鍍處理，因此絕對不會發生螺紋磨損問題。

規格、材質

規 格	設計壓力	16.2MPa
	使用溫度範圍	-196°C~350°C
材 質	母螺帽(NUT)	SUS316
	本體(BODY)	SUS316
	前環(FRONT RING)	SUS316
	後環(BACK RING)	SUS316

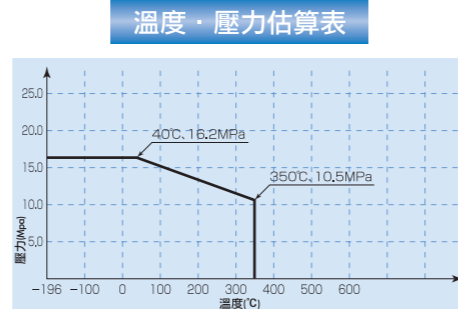

施工

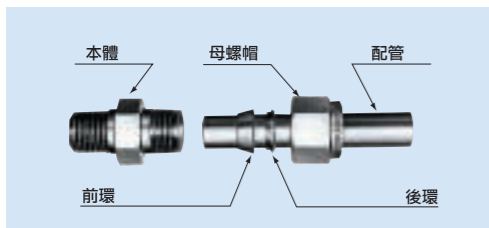

① 確認接頭零件是否確實按照照片中的順序正確地安裝。

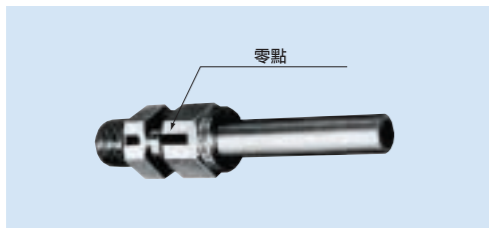

② 將配管端完全插入本體肩部(BODY SHOULDER)，接著利用手指將母螺帽旋轉到底後，在本體與母螺帽接處畫上適當的符號。以此符號為零點。

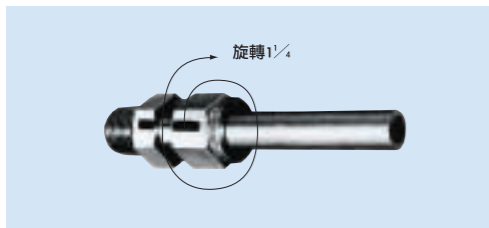

③ 從零點的位置開始，利用扳手將母螺帽旋轉1/4圈。至此完成所有栓緊步驟。

型號表示

F900接頭是以下列方式訂定型號，故訂貨、洽詢之際，敬請告知以下型號。

F900接頭型號訂定方式



◆接頭形狀

H	半連管接頭	TS	TS連管接頭
F	直式連管接頭	TG	T型儀錶連管接頭
G	異徑直式連管接頭	TLG	TL儀錶連管接頭
P	儀錶連管接頭	HP	半面板連管接頭
R	面板連管接頭	GP	儀錶面板連管接頭
L	減壓器	X	十字型連管接頭
LG	彎管連管接頭	JP	連管塞
T	彎管半連管接頭	JC	連管接頭管帽
TL	彎管儀錶連管接頭	PC	接埠連接器
	T型連管接頭	RP	面板減壓連管接頭
	異徑T型連管接頭	LR	彎管減壓器連管接頭
	T型彎管連管接頭	AT	配管轉接器
		ATG	配管儀錶轉接器

◆螺絲尺寸

管用錐形螺絲※						
螺絲尺寸符號	A	B	C	D	E	F
JIS B0203(1981)	PT1/8	PT1/4	PT3/8	PT1/2	PT3/4	PT1
JIS B0203 (1982)	公螺絲 R1/8	R1/4	R3/8	R1/2	R3/4	R1
	母螺絲 Rc1/8	Rc1/4	Rc3/8	Rc1/2	Rc3/4	Rc1
美國管用螺絲						
螺絲尺寸符號	AN	BN	CN	DN	EN	
ANSI B1.20.1	1/8NPT	1/4NPT	3/8NPT	1/2NPT	3/4NPT	

管用平行螺絲				
螺絲尺寸符號	AF	BF	CF	DF
JIS B0202(1981)	PF1/8	PF1/4	PF3/8	PF1/2
JIS B0202(1982)	G1/8	G1/4	G3/8	G1/2

配管尺寸對照表

口徑 (配管外徑)	3.2表示1/8 ^{OD}
	6.35表示1/4 ^{OD}
	9.52表示3/8 ^{OD}
	12.7表示1/2 ^{OD}
	19.05表示3/4 ^{OD}
	25.4表示1 ^{OD}



半連管接頭(R螺絲)

(單位: mm)

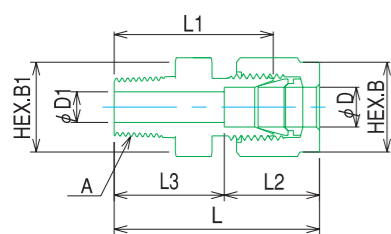

口徑D	A	D1	B	B1	L	L1	L2	L3	型號
3.2	R1/8	2.7	10	12	30	23.5	13	17	F900-H-3.2A
3.2	R1/4	2.7	10	14	33	26.5	13	20	F900-H-3.2B
6.35	R1/8	5	14	14	33	26	15	18	F900-H-6.35A
6.35	R1/4	5	14	14	36	29	15	21	F900-H-6.35B
6.35	R3/8	5	14	17	37	30	15	22	F900-H-6.35C
6.35	R1/2	5	14	22	42	35	15	27	F900-H-6.35D
9.52	R1/8	5	17	17	36	28	17.5	18.5	F900-H-9.52A
9.52	R1/4	7.5	17	17	39	31	17.5	21.5	F900-H-9.52B
9.52	R3/8	7.5	17	17	40	32	17.5	22.5	F900-H-9.52C
9.52	R1/2	7.5	17	22	44	36	17.5	26.5	F900-H-9.52D
12.7	R1/8	5	22	22	41.5	30.5	24	17.5	F900-H-12.7A
12.7	R1/4	7.5	22	22	44.5	33.5	24	20.5	F900-H-12.7B
12.7	R3/8	10	22	22	45.5	34.5	24	21.5	F900-H-12.7C
12.7	R1/2	10	22	22	48.5	37.5	24	24.5	F900-H-12.7D
19.05	R1/8	5	29	29	44.5	33.5	25.2	19.3	F900-H-19.05A
19.05	R1/4	7.5	29	29	47.5	36.5	25.2	22.3	F900-H-19.05B
19.05	R3/8	10	29	29	48.5	37.5	25.2	23.3	F900-H-19.05C
19.05	R1/2	12.7	29	29	51.5	40.5	25.2	26.3	F900-H-19.05D
19.05	R3/4	16	29	29	53.5	42.5	25.2	28.3	F900-H-19.05E
19.05	R1	16	29	29	58.5	47.5	25.2	33.3	F900-H-19.05F
25.4	R3/4	15.7	38	35	57.4	45.2	31.2	26.2	F900-H-25.4E
25.4	R1	22.4	38	35	62.2	50	31.2	31	F900-H-25.4F

半連管接頭(NPT螺絲)

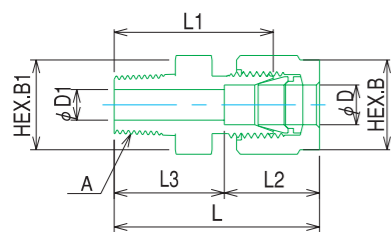

口徑D	A	D1	B	B1	L	L1	L2	L3	型號
3.2	1/8NPT	2.7	10	12	30	23.5	13	17	F900-H-3.2AN
3.2	1/4NPT	2.7	10	14	33	26.5	13	20	F900-H-3.2BN
6.35	1/8NPT	5	14	14	33	26	15	18	F900-H-6.35AN
6.35	1/4NPT	5	14	14	36	29	15	21	F900-H-6.35BN
6.35	3/8NPT	5	14	19	37	30	15	22	F900-H-6.35CN
6.35	1/2NPT	5	14	22	42	35	15	27	F900-H-6.35DN
9.52	1/8NPT	5	17	17	36	28	17.5	18.5	F900-H-9.52AN
9.52	1/4NPT	7.5	17	17	39	31	17.5	21.5	F900-H-9.52BN
9.52	3/8NPT	7.5	17	19	40	32	17.5	22.5	F900-H-9.52CN
9.52	1/2NPT	7.5	17	22	44	36	17.5	26.5	F900-H-9.52DN
12.7	1/8NPT	5	22	22	41.5	30.5	24	17.5	F900-H-12.7AN
12.7	1/4NPT	7.5	22	22	44.5	33.5	24	20.5	F900-H-12.7BN
12.7	3/8NPT	10	22	22	45.5	34.5	24	21.5	F900-H-12.7CN
12.7	1/2NPT	10	22	22	48.5	37.5	24	24.5	F900-H-12.7DN
19.05	1/8NPT	5	29	29	44.5	33.5	25.2	19.3	F900-H-19.05AN
19.05	1/4NPT	7.5	29	29	47.5	36.5	25.2	22.3	F900-H-19.05BN
19.05	3/8NPT	10	29	29	48.5	37.5	25.2	23.3	F900-H-19.05CN
19.05	1/2NPT	12.7	29	29	51.5	40.5	25.2	26.3	F900-H-19.05DN
19.05	3/4NPT	16	29	29	53.5	42.5	25.2	28.3	F900-H-19.05EN

熱電偶式半連管接頭(R螺絲)

(單位: mm)

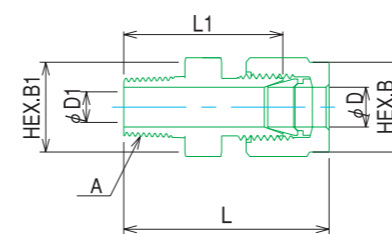

口徑D	A	D1	B	B1	L	L1	型號
3.2	R1/8	3.3	10	12	30	23.5	F900-H-3.2A-TC
3.2	R1/4	3.3	10	14	33	26.5	F900-H-3.2B-TC
6.35	R1/4	6.5	14	14	36	29	F900-H-6.35B-TC
6.35	R3/8	6.5	14	17	37	30	F900-H-6.35C-TC
6.35	R1/2	6.5	14	22	42	35	F900-H-6.35D-TC
9.52	R3/8	9.7	17	17	40	32	F900-H-9.52C-TC
9.52	R1/2	9.7	17	22	44	36	F900-H-9.52D-TC
12.7	R1/2	12.9	22	22	48.5	37.5	F900-H-12.7D-TC
12.7	R3/4	12.9	22	29	52	41	F900-H-12.7E-TC
19.05	R3/4	19.2	29	29	53.5	42.5	F900-H-19.05E-TC

O型環半連管接頭(UNF螺絲)

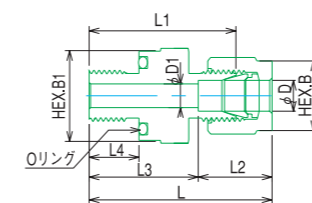

口徑D	A	D1	B	B1	L	L1	L2	L3	L4	O環尺寸	型號
3.2	5/16-24UNF	2.7	10	14	32.5	26	13	19.5	8.5	P8	F900-H-3.2x5/16-24-OR
6.35	7/16-20UNF	5	14	19	38	31	15	23	10.5	P12.5	F900-H-6.35x7/16-20-OR
9.52	9/16-18UNF	7.5	17	26	42	34	17.5	24.5	12	P18	F900-H-9.52x9/16-18-OR
12.7	3/4-16UNF	10	22	29	47	36	24	23	12	P21	F900-H-12.7x3/4-16-OR

半面板連管接頭(R螺絲)

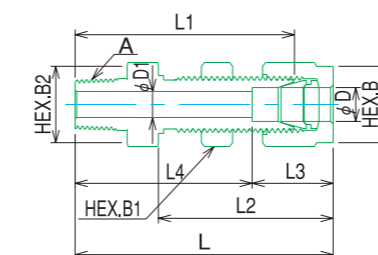

口徑D	A	面板孔徑	D1	B	B1	B2	L	L1	L2	L3	L4	型號
3.2	R1/8	8	2.7	10	12	12	44	37.5	29	13	31	F900-HP-3.2A
3.2	R1/4	8	2.7	10	12	14	47	40.5	29	13	34	F900-HP-3.2B
6.35	R1/8	11.2	5	14	14	14	49	42	33	15	34	F900-HP-6.35A
6.35	R1/4	11.2	5	14	14	14	52	45	33	15	37	F900-HP-6.35B
6.35	R3/8	11.2	5	14	14	17	53	46	33	15	38	F900-HP-6.35C
6.35	R1/2	11.2	5	14	14	22	58	51	33	15	43	F900-HP-6.35D
9.52	R1/8	14.3	5	17	19	19	54	46	37	17.5	36.5	F900-HP-9.52A
9.52	R1/4	14.3	7.5	17	19	19	57	49	37	17.5	39.5	F900-HP-9.52B
9.52	R3/8	14.3	7.5	17	19	19	58	50	37	17.5	40.5	F900-HP-9.52C
9.52	R1/2	14.3	7.5	17	19	22	62	54	37	17.5	44.5	F900-HP-9.52D
12.7	R1/8	19.1	5	22	23	23	59	48	40.5	24	35	F900-HP-12.7A
12.7	R1/4	19.1	7.5	22	23	23	62	51	40.5	24	38	F900-HP-12.7B
12.7	R3/8	19.1	10	22	23	23	63	52	40.5	24	39	F900-HP-12.7C
12.7	R1/2	19.1	10	22	23	23	66	55	40.5	24	42	F900-HP-12.7D



(單位: mm)

半面板連管接頭(NPT螺絲)

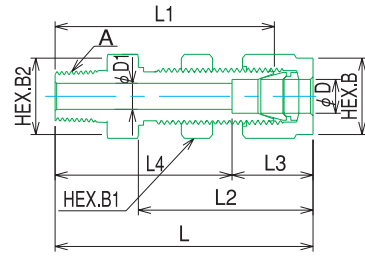

口徑D	A	面板孔徑	D1	B	B1	B2	L	L1	L2	L3	L4	型號
3.2	1/8NPT	8	2.7	10	12	12	44	37.5	29	13	31	F900-HP-3.2AN
3.2	1/4NPT	8	2.7	10	12	14	47	40.5	29	13	34	F900-HP-3.2BN
6.35	1/8NPT	11.2	5	14	14	14	49	42	33	15	34	F900-HP-6.35AN
6.35	1/4NPT	11.2	5	14	14	14	52	45	33	15	37	F900-HP-6.35BN
6.35	3/8NPT	11.2	5	14	14	19	53	46	33	15	38	F900-HP-6.35CN
6.35	1/2NPT	11.2	5	14	14	22	58	51	33	15	43	F900-HP-6.35DN
9.52	1/8NPT	14.3	5	17	19	19	54	46	37	17.5	36.5	F900-HP-9.52AN
9.52	1/4NPT	14.3	7.5	17	19	19	57	49	37	17.5	39.5	F900-HP-9.52BN
9.52	3/8NPT	14.3	7.5	17	19	19	58	50	37	17.5	40.5	F900-HP-9.52CN
9.52	1/2NPT	14.3	7.5	17	19	22	62	54	37	17.5	44.5	F900-HP-9.52DN
12.7	1/8NPT	19.1	5	22	23	23	59	48	40.5	24	35	F900-HP-12.7AN
12.7	1/4NPT	19.1	7.5	22	23	23	62	51	40.5	24	38	F900-HP-12.7BN
12.7	3/8NPT	19.1	10	22	23	23	63	52	40.5	24	39	F900-HP-12.7CN
12.7	1/2NPT	19.1	10	22	23	23	66	55	40.5	24	42	F900-HP-12.7DN

直式連管接頭

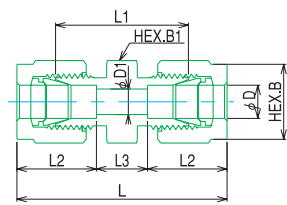

口徑D	D1	B	B1	L	L1	L2	L3	型號
3.2	2.7	10	10	35	22	13	9	F900-F-3.2
6.35	5	14	14	40	26	15	10	F900-F-6.35
9.52	7.5	17	17	45	29	17.5	10	F900-F-9.52
12.7	10	22	22	54.5	32.5	24	6.5	F900-F-12.7
19.05	16	29	29	59	37	25.2	8.6	F900-F-19.05
25.4	22.4	38	35	64.8	40.4	31.2		F900-F-25.4

異徑直式連管接頭

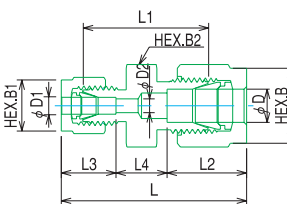

口徑D	口徑D1	D2	B	B1	B2	L	L1	L2	L3	L4	型號
6.35	3.2	2.7	14	10	14	38	24.5	15	13	10	F900-F-6.35×3.2
9.52	3.2	2.7	17	10	17	41	26.5	17.5	13	10.5	F900-F-9.52×3.2
9.52	6.35	5	17	14	17	43	28	17.5	15	10.5	F900-F-9.52×6.35
12.7	6.35	5	22	14	22	48.5	30.5	24	15	9.5	F900-F-12.7×6.35
12.7	9.52	7.5	22	17	22	50.5	31.5	24	17.5	9	F900-F-12.7×9.52
19.05	6.35	5	29	14	29	51.5	33.5	25.2	15	11.3	F900-F-19.05×6.35
19.05	9.52	7.5	29	17	29	53.5	34.5	25.2	17.5	10.8	F900-F-19.05×9.52
19.05	12.7	10	29	22	29	57.5	35.5	25.2	24	8.3	F900-F-19.05×12.7
25.4	19.05	15.7	38	29	35	60.5	38.1	31.2	24.4	4.9	F900-F-25.4×19.05

面板連管接頭

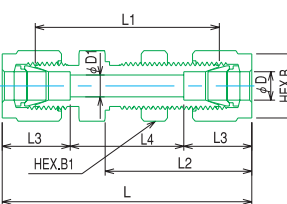

口徑D	面板孔徑	D1	B	B1	L	L1	L2	L3	L4	型號
3.2	8	2.7	10	12	49	36	29	13	23	F900-P-3.2
6.35	11.2	5	14	14	56	42	33	15	26	F900-P-6.35
9.52	14.3	7.5	17	19	63	47	37	17.5	28	F900-P-9.52
12.7	19.1	10	22	23	72	50	40.5	24	24	F900-P-12.7
19.05	25.5	16	29	32	81	59	46.5	25.2	30.6	F900-P-19.05
25.4	33.7	22.4	38	41	95.8	71.4	57.4	31.2	33.4	F900-P-25.4

(單位: mm)

儀錶連管接頭(G螺絲)

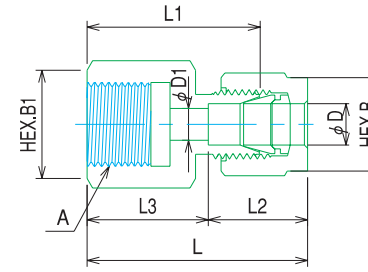

口徑D	A	D1	B	B1	L	L1	L2	L3	型號
3.2	G1/8	5.5	10	14	29	22.5	13	16	F900-G-3.2AF
3.2	G1/4	5.5	10	17	32	25.5	13	19	F900-G-3.2BF
6.35	G1/8	5.5	14	14	31	24	15	16	F900-G-6.35AF
6.35	G1/4	5.5	14	17	34	27	15	19	F900-G-6.35BF
6.35	G3/8	5.5	14	21	36	29	15	21	F900-G-6.35CF
6.35	G1/2	5.5	14	26	40	33	15	25	F900-G-6.35DF
9.52	G1/8	5.5	17	17	33	25	17.5	15.5	F900-G-9.52AF
9.52	G1/4	5.5	17	17	36	28	17.5	18.5	F900-G-9.52BF
9.52	G3/8	5.5	17	21	38	30	17.5	20.5	F900-G-9.52CF
9.52	G1/2	5.5	17	26	42	34	17.5	24.5	F900-G-9.52DF
12.7	G1/8	5.5	22	22	37	26	24	13	F900-G-12.7AF
12.7	G1/4	5.5	22	22	40	29	24	16	F900-G-12.7BF
12.7	G3/8	5.5	22	22	42	31	24	18	F900-G-12.7CF
12.7	G1/2	5.5	22	26	46	35	24	22	F900-G-12.7DF

儀錶連管接頭(Rc螺絲)

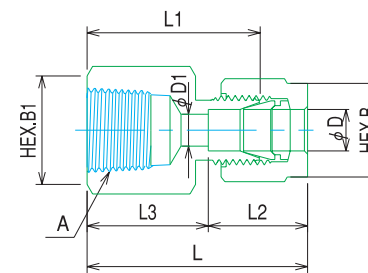

口徑D	A	D1	B	B1	L	L1	L2	L3	型號
3.2	Rc1/8	2.7	10	14	29	22.5	13	16	F900-G-3.2A
3.2	Rc1/4	2.7	10	17	32	25.5	13	19	F900-G-3.2B
6.35	Rc1/8	5	14	14	31	24	15	16	F900-G-6.35A
6.35	Rc1/4	5	14	17	34	27	15	19	F900-G-6.35B
6.35	Rc3/8	5	14	21	36	29	15	21	F900-G-6.35C
6.35	Rc1/2	5	14	26	40	33	15	25	F900-G-6.35D
9.52	Rc1/8	7	17	17	33	25	17.5	15.5	F900-G-9.52A
9.52	Rc1/4	7.5	17	17	36	28	17.5	18.5	F900-G-9.52B
9.52	Rc3/8	7.5	17	21	38	30	17.5	20.5	F900-G-9.52C
9.52	Rc1/2	7.5	17	26	42	34	17.5	24.5	F900-G-9.52D
12.7	Rc1/8	7	22	22	37	26	24	13	F900-G-12.7A
12.7	Rc1/4	10	22	22	40	29	24	16	F900-G-12.7B
12.7	Rc3/8	10	22	22	42	31	24	18	F900-G-12.7C
12.7	Rc1/2	10	22	26	46	35	24	22	F900-G-12.7D

儀錶連管接頭(NPT螺絲)

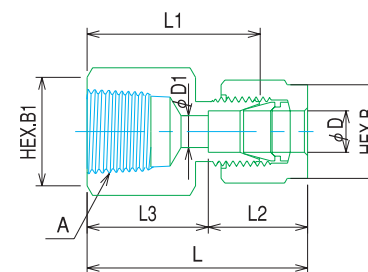

口徑D	A	D1	B	B1	L	L1	L2	L3	型號
3.2	1/8NPT	2.7	10	14	29	22.5	13	16	F900-G-3.2AN
3.2	1/4NPT	2.7	10	17	32	25.5	13	19	F900-G-3.2BN
6.35	1/8NPT	5	14	14	31	24	15	16	F900-G-6.35AN
6.35	1/4NPT	5	14	17	34	27	15	19	F900-G-6.35BN
6.35	3/8NPT	5	14	21	36	29	15	21	F900-G-6.35CN
6.35	1/2NPT	5	14	26	40	33	15	25	F900-G-6.35DN
9.52	1/8NPT	7	17	17	33	25	17.5	15.5	F900-G-9.52AN
9.52	1/4NPT	7.5	17	17	36	28	17.5	18.5	F900-G-9.52BN
9.52	3/8NPT	7.5	17	21	38	30	17.5	20.5	F900-G-9.52CN
9.52	1/2NPT	7.5	17	26	42	34	17.5	24.5	F900-G-9.52DN
12.7	1/8NPT	7	22	22	37	26	24	13	F900-G-12.7AN
12.7	1/4NPT	10	22	22	40	29	24	16	F900-G-12.7BN
12.7	3/8NPT	10	22	22	42	31	24	18	F900-G-12.7CN
12.7	1/2NPT	10	22	26	46	35	24	22	F900-G-12.7DN



(單位：mm)

儀錶面板連管接頭(Rc螺絲)

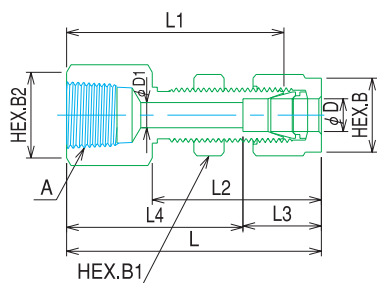

口徑D	A	面板孔徑	D1	B	B1	B2	L	L1	L2	L3	L4	型號
3.2	Rc1/8	8	2.7	10	12	14	43	36.5	29	13	30	F900-GP-3.2A
3.2	Rc1/4	8	2.7	10	12	17	46	39.5	29	13	33	F900-GP-3.2B
6.35	Rc1/8	11.2	5	14	14	14	47	40	33	15	32	F900-GP-6.35A
6.35	Rc1/4	11.2	5	14	14	17	50	43	33	15	35	F900-GP-6.35B
6.35	Rc3/8	11.2	5	14	14	21	52	45	33	15	37	F900-GP-6.35C
9.52	Rc1/8	14.3	7	17	19	19	51	43	37	17.5	33.5	F900-GP-9.52A
9.52	Rc1/4	14.3	7.5	17	19	19	54	46	37	17.5	36.5	F900-GP-9.52B
9.52	Rc3/8	14.3	7.5	17	19	21	56	48	37	17.5	38.5	F900-GP-9.52C
12.7	Rc1/8	19.1	7	22	23	23	54.5	43.5	40.5	24	30.5	F900-GP-12.7A
12.7	Rc1/4	19.1	10	22	23	23	57.5	46.5	40.5	24	33.5	F900-GP-12.7B
12.7	Rc3/8	19.1	10	22	23	23	59.5	48.5	40.5	24	35.5	F900-GP-12.7C

儀錶面板連管接頭(NPT螺絲)

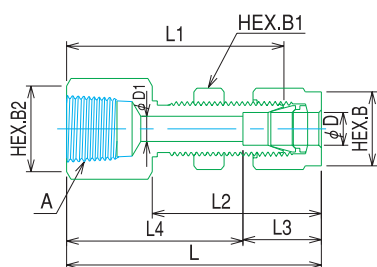

口徑D	A	面板孔徑	D1	B	B1	B2	L	L1	L2	L3	L4	型號
3.2	1/8NPT	8	2.7	10	12	14	43	36.5	29	13	30	F900-GP-3.2AN
3.2	1/4NPT	8	2.7	10	12	17	46	39.5	29	13	33	F900-GP-3.2BN
6.35	1/8NPT	11.2	5	14	14	14	47	40	33	15	32	F900-GP-6.35AN
6.35	1/4NPT	11.2	5	14	14	17	50	43	33	15	35	F900-GP-6.35BN
6.35	3/8NPT	11.2	5	14	14	21	52	45	33	15	37	F900-GP-6.35CN
9.52	1/8NPT	14.3	7	17	19	19	51	43	37	17.5	33.5	F900-GP-9.52AN
9.52	1/4NPT	14.3	7.5	17	19	19	54	46	37	17.5	36.5	F900-GP-9.52BN
9.52	3/8NPT	14.3	7.5	17	19	21	56	48	37	17.5	38.5	F900-GP-9.52CN
12.7	1/8NPT	19.1	7	22	23	23	54.5	43.5	40.5	24	30.5	F900-GP-12.7AN
12.7	1/4NPT	19.1	10	22	23	23	57.5	46.5	40.5	24	33.5	F900-GP-12.7BN
12.7	3/8NPT	19.1	10	22	23	23	59.5	48.5	40.5	24	35.5	F900-GP-12.7CN

減壓連管接頭

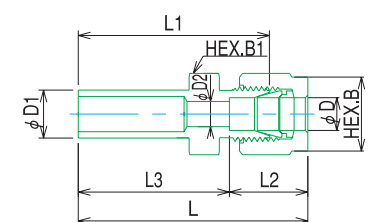

口徑D	D1	D2	B	B1	L	L1	L2	L3	型號
3.2	6.35	2.7	10	10	39	32.5	13	26	F900-R-3.2×6.35
3.2	9.52	2.7	10	10	42	35.5	13	29	F900-R-3.2×9.52
6.35	3.2	2	14	14	39	32	15	24	F900-R-6.35×3.2
6.35	9.52	5	14	14	45	38	15	30	F900-R-6.35×9.52
6.35	12.7	5	14	14	51.5	44.5	15	36.5	F900-R-6.35×12.7
9.52	6.35	4.3	17	17	45	37	17.5	27.5	F900-R-9.52×6.35
9.52	12.7	7.5	17	17	54.5	46.5	17.5	37	F900-R-9.52×12.7
12.7	6.35	4.3	22	22	50.5	39.5	24	26.5	F900-R-12.7×6.35
12.7	9.52	7.5	22	22	53.5	42.5	24	29.5	F900-R-12.7×9.52
12.7	19.05	15	22	22	57.5	46.5	26		F900-R-12.7×19.05

面板減壓連管接頭

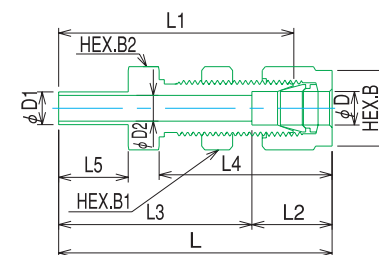

口徑D	面板孔徑	D1	D2	B	B1	B2	L	L1	L2	L3	L4	L5	型號
3.2	8	3.2	1.8	10	12	12	47.5	41	13	34.5	29	13.5	F900-RP-3.2×3.2
6.35	11.2	6.35	4.5	14	14	14	55	48	15	40	33	16	F900-RP-6.35×6.35
9.52	14.3	9.52	7	17	19	19	62	54	17.5	44.5	37	18	F900-RP-9.52×9.52
12.7	19.1	12.7	10	22	23	23	73.5	62.5	24	49.5	40.5	24.5	F900-RP-12.7×12.7

減壓連管接頭 (插入熔接式)

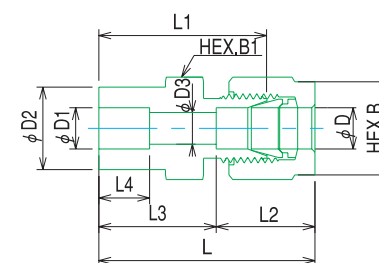

口徑D	D1	D2	D3	B	B1	L	L1	L2	L3	L4	型號
3.2	3.3	8	2.7	10	10	28.5	22	13	15.5	6.5	F900-R-3.2×3.2F
6.35	6.5	13	5	14	14	33.5	26.5	15	18.5	8	F900-R-6.35×6.35F
9.52	9.7	16	7.5	17	17	38	30	17.5	20.5	10	F900-R-9.52×9.52F
12.7	12.9	21	10	22	22	43	32	24	19	13	F900-R-12.7×12.7F

減壓連管接頭 (對口熔接式)

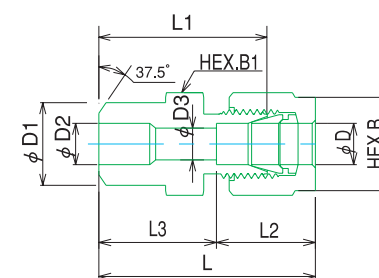

口徑D	D1	D2	D3	B	B1	L	L1	L2	L3	型號
3.2	10.3	4.8	2.7	10	12	30	23.5	13	17	F900-R-3.2×10.3M
3.2	13.7	7.1	2.7	10	14	36	29.5	13	23	F900-R-3.2×13.7M
6.35	10.3	4.8	4.8	14	14	33	26	15	18	F900-R-6.35×10.3M
6.35	13.7	7.1	5	14	14	38	31	15	23	F900-R-6.35×13.7M
6.35	17.15	10.4	5	14	19	39	32	15	24	F900-R-6.35×17.15M
9.52	13.7	7.1	7.1	17	17	41	33	17.5	23.5	F900-R-9.52×13.7M
9.52	17.15	10.4	7.5	17	19	41	33	17.5	23.5	F900-R-9.52×17.15M
9.52	21.35	13.2	7.5	17	22	45	37	17.5	27.5	F900-R-9.52×21.35M
12.7	13.7	7.1	7.1	22	22	46.5	35.5	24	22.5	F900-R-12.7×13.7M
12.7	17.15	10.4	10.4	22	22	46.5	35.5	24	22.5	F900-R-12.7×17.15M
12.7	21.35	13.2	10	22	22	49	38	24	25	F900-R-12.7×21.35M

彎管連管接頭

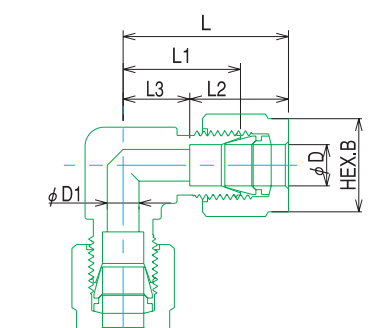

口徑D	D1	B	L	L1	L2	L3	型號
3.2	2.7	10	23.5	17	13	10.5	F900-L-3.2
6.35	5	14	25.5	18.5	15	10.5	F900-L-6.35
9.52	7.5	17	30	22	17.5	12.5	F900-L-9.52
12.7	10	22	36	25	24	12	F900-L-12.7
19.05	16	29	41	30	25.2	15.8	F900-L-19.05
25.4	22.4	38	49	36.8	31.2	17.8	F900-L-25.4



(單位：mm)

彎管半連管接頭(R螺絲)

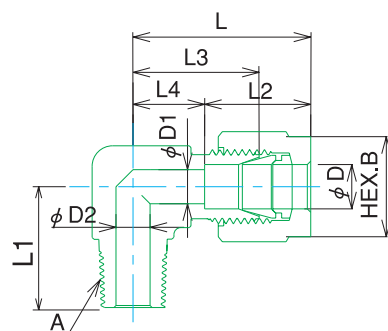

口徑D	A	D1	D2	B	L	L1	L2	L3	L4	型號
3.2	R1/8	2.7	5	10	23.5	20	13	17	10.5	F900-L-3.2A
3.2	R1/4	2.7	5	10	23.5	22	13	17	10.5	F900-L-3.2B
6.35	R1/8	5	5	14	25.5	20	15	18.5	10.5	F900-L-6.35A
6.35	R1/4	5	5	14	25.5	22	15	18.5	10.5	F900-L-6.35B
6.35	R3/8	5	5	14	29	25	15	22	14	F900-L-6.35C
6.35	R1/2	5	5	14	32	32	15	25	17	F900-L-6.35D
9.52	R1/8	7.5	5	17	30	24	17.5	22	12.5	F900-L-9.52A
9.52	R1/4	7.5	7.5	17	30	24	17.5	22	12.5	F900-L-9.52B
9.52	R3/8	7.5	7.5	17	30	25	17.5	22	12.5	F900-L-9.52C
9.52	R1/2	7.5	7.5	17	33	32	17.5	25	15.5	F900-L-9.52D
12.7	R1/8	10	5	22	36	29	24	25	12	F900-L-12.7A
12.7	R1/4	10	7.5	22	36	29	24	25	12	F900-L-12.7B
12.7	R3/8	10	10	22	36	29	24	25	12	F900-L-12.7C
12.7	R1/2	10	10	22	36	32	24	25	12	F900-L-12.7D
19.05	R3/8	16	10	29	41	32	30	25.2	15.8	F900-L-19.05C
19.05	R1/2	16	12.7	29	41	35	30	25.2	15.8	F900-L-19.05D
19.05	R3/4	16	16	29	41	37	30	25.2	15.8	F900-L-19.05E
25.4	R3/4	22.4	15.7	38	49	41.7	31.2	36.8	17.8	F900-L-25.4E
25.4	R1	22.4	22.4	38	49	46.5	31.2	36.8	17.8	F900-L-25.4F

彎管半連管接頭 (NPT螺絲)

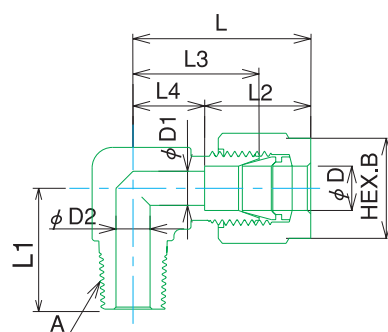

口徑D	A	D1	D2	B	L	L1	L2	L3	L4	型號
3.2	1/8NPT	2.7	5	10	23.5	20	13	17	10.5	F900-L-3.2AN
3.2	1/4NPT	2.7	5	10	23.5	22	13	17	10.5	F900-L-3.2BN
6.35	1/8NPT	5	5	14	25.5	20	15	18.5	10.5	F900-L-6.35AN
6.35	1/4NPT	5	5	14	25.5	22	15	18.5	10.5	F900-L-6.35BN
6.35	3/8NPT	5	5	14	29	25	15	22	14	F900-L-6.35CN
6.35	1/2NPT	5	5	14	32	32	15	25	17	F900-L-6.35DN
9.52	1/8NPT	7.5	5	17	30	24	17.5	22	12.5	F900-L-9.52AN
9.52	1/4NPT	7.5	7.5	17	30	24	17.5	22	12.5	F900-L-9.52BN
9.52	3/8NPT	7.5	7.5	17	30	25	17.5	22	12.5	F900-L-9.52CN
9.52	1/2NPT	7.5	7.5	17	33	32	17.5	25	15.5	F900-L-9.52DN
12.7	1/8NPT	10	5	22	36	29	24	25	12	F900-L-12.7AN
12.7	1/4NPT	10	7.5	22	36	29	24	25	12	F900-L-12.7BN
12.7	3/8NPT	10	10	22	36	29	24	25	12	F900-L-12.7CN
12.7	1/2NPT	10	10	22	36	32	24	25	12	F900-L-12.7DN
19.05	3/8NPT	16	10	29	41	32	25.2	30	15.8	F900-L-19.05CN
19.05	1/2NPT	16	12.7	29	41	35	25.2	30	15.8	F900-L-19.05DN
19.05	3/4NPT	16	16	29	41	37	25.2	30	15.8	F900-L-19.05EN

彎管儀錶連管接頭(Rc螺絲)

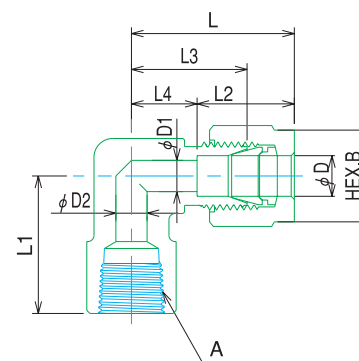

口徑D	A	D1	D2	B	L	L1	L2	L3	L4	型號
3.2	Rc1/8	2.7	7	10	23.5	20	13	17	10.5	F900-LG-3.2A
3.2	Rc1/4	2.7	7	10	26	22	13	19.5	13	F900-LG-3.2B
6.35	Rc1/8	5	7	14	25.5	20	15	18.5	10.5	F900-LG-6.35A
6.35	Rc1/4	5	7	14	29	22	15	22	14	F900-LG-6.35B
6.35	Rc3/8	5	7	14	32	26	15	25	17	F900-LG-6.35C
9.52	Rc1/8	7.5	7	17	30	22	17.5	22	12.5	F900-LG-9.52A
9.52	Rc1/4	7.5	7.5	17	30	22	17.5	22	12.5	F900-LG-9.52B
9.52	Rc3/8	7.5	7.5	17	33	26	17.5	25	15.5	F900-LG-9.52C
12.7	Rc1/8	10	7	22	36	26	24	25	12	F900-LG-12.7A
12.7	Rc1/4	10	10	22	36	26	24	25	12	F900-LG-12.7B
12.7	Rc3/8	10	10	22	36	26	24	25	12	F900-LG-12.7C

彎管儀錶連管接頭(NPT螺絲)

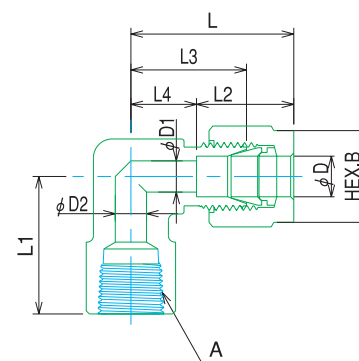

口徑D	A	D1	D2	B	L	L1	L2	L3	L4	型號
3.2	1/8NPT	2.7	7	10	23.5	20	13	17	10.5	F900-LG-3.2AN
3.2	1/4NPT	2.7	7	10	26	22	13	19.5	13	F900-LG-3.2BN
6.35	1/8NPT	5	7	14	25.5	20	15	18.5	10.5	F900-LG-6.35AN
6.35	1/4NPT	5	7	14	29	22	15	22	14	F900-LG-6.35BN
6.35	3/8NPT	5	7	14	32	26	15	25	17	F900-LG-6.35CN
9.52	1/8NPT	7.5	7	17	30	22	17.5	22	12.5	F900-LG-9.52AN
9.52	1/4NPT	7.5	7.5	17	30	22	17.5	22	12.5	F900-LG-9.52BN
9.52	3/8NPT	7.5	7.5	17	33	26	17.5	25	15.5	F900-LG-9.52CN
12.7	1/8NPT	10	7	22	36	26	24	25	12	F900-LG-12.7AN
12.7	1/4NPT	10	10	22	36	26	24	25	12	F900-LG-12.7BN
12.7	3/8NPT	10	10	22	36	26	24	25	12	F900-LG-12.7CN

彎管減壓連管接頭 (插入熔接式)

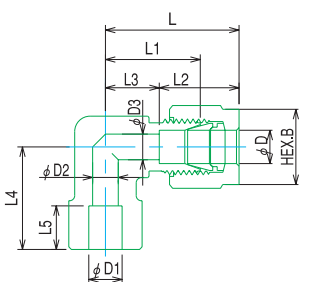

口徑D	D1	D2	D3	B	L	L1	L2	L3	L4	L5	型號
3.2	3.3	2.7	2.7	10	23.5	17	13	10.5	20	6.5	F900-LR-3.2×3.2F
6.35	6.5	5	5	14	25.5	18.5	15	10.5	20	8	F900-LR-6.35×6.35F
9.52	9.7	7.5	7.5	17	30	22	17.5	12.5	22	10	F900-LR-9.52×9.52F
12.7	12.9	7	7	22	36	25	24	12	26	13	F900-LR-12.7×12.7F



彎管減壓連管接頭(對口熔接式)

(單位: mm)

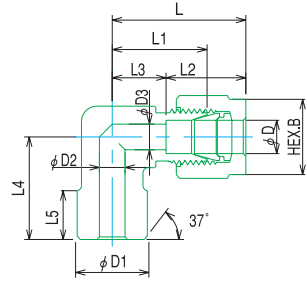

口徑D	D1	D2	D3	B	L	L1	L2	L3	L4	L5	型號
6.35	10.3	4.8	5	14	25.5	18.5	15	10.5	20	11	F900-LR-6.35×10.3M
6.35	13.7	7.1	5	14	25.5	18.5	15	10.5	22	13	F900-LR-6.35×13.7M
9.52	13.7	7.1	7.5	17	30	22	17.5	12.5	25	13	F900-LR-9.52×13.7M
12.7	21.3	13.2	10	22	36	25	24	12	32	17	F900-LR-12.7×21.35M

T型連管接頭

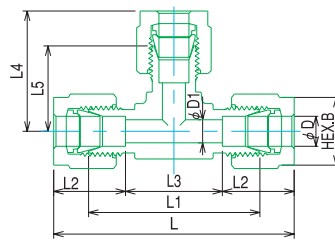

口徑D	D1	B	L	L1	L2	L3	L4	L5	型號
3.2	2.7	10	47	34	13	21	23.5	17	F900-T-3.2
6.35	5	14	51	37	15	21	25.5	18.5	F900-T-6.35
9.52	7.5	17	60	44	17.5	25	30	22	F900-T-9.52
12.7	10	22	72	50	24	24	36	25	F900-T-12.7
19.05	16	29	82	60	25.2	31.6	41	30	F900-T-19.05
25.4	22.4	38	98	73.6	31.2	35.6	49	36.8	F900-T-25.4

異徑T型連管接頭

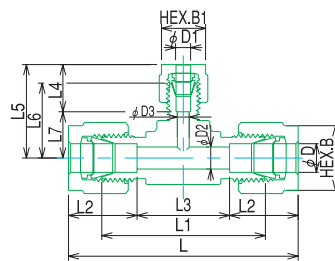

口徑D	口徑D1	D2	D3	B	B1	L	L1	L2	L3	L4	L5	L6	L7	型號
9.52	6.35	7.5	5	17	14	60	44	17.5	25	15	29	22	14	F900-T-9.52×9.52×6.35
12.7	6.35	10	5	22	14	72	50	24	24	15	32	25	17	F900-T-12.7×12.7×6.35
12.7	9.52	10	7.5	22	17	72	50	24	24	17.5	33	25	15.5	F900-T-12.7×12.7×9.52
19.05	6.35	16	5	29	14	82	60	25.2	31.6	15	37	30	22	F900-T-19.05×19.05×6.35
19.05	9.52	16	7.5	29	17	82	60	25.2	31.6	17.5	38	30	20.5	F900-T-19.05×19.05×9.52
19.05	12.7	16	10	29	22	82	60	25.2	31.6	24	41	30	17	F900-T-19.05×19.05×12.7
25.4	19.05	22.4	16	38	29	97.9	73.6	31.2	35.5	25.2	47.8	36.8	22.6	F900-T-25.4×25.4×19.05

十字型連管接頭

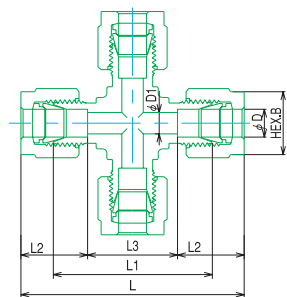

口徑D	D1	B	L	L1	L2	L3	型號
3.2	2.7	10	47	34	13	21	F900-X-3.2
6.35	5	14	51	37	15	21	F900-X-6.35
9.52	7.5	17	60	44	17.5	25	F900-X-9.52
12.7	10	22	72	50	24	24	F900-X-12.7

T型儀錶連管接頭 (G螺絲)

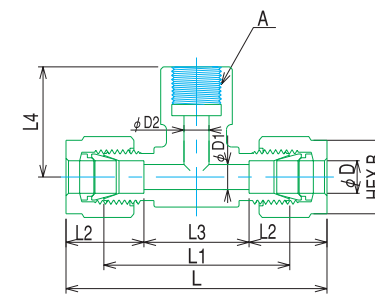

口徑D	A	D1	D2	B	L	L1	L2	L3	L4	型號
3.2	G1/8	2.7	5.5	10	47	34	13	21	22	F900-TG-3.2AF
3.2	G1/4	2.7	5.5	10	52	39	13	26	25.5	F900-TG-3.2BF
6.35	G1/8	5	5.5	14	51	37	15	21	22	F900-TG-6.35AF
6.35	G1/4	5	5.5	14	58	44	15	28	25.5	F900-TG-6.35BF
6.35	G3/8	5	5.5	14	64	50	15	34	32	F900-TG-6.35CF
9.52	G1/8	7.5	5.5	17	60	44	17.5	25	22	F900-TG-9.52AF
9.52	G1/4	7.5	5.5	17	60	44	17.5	25	25.5	F900-TG-9.52BF
9.52	G3/8	7.5	5.5	17	66	50	17.5	31	32	F900-TG-9.52CF
12.7	G1/8	10	5.5	22	72	50	24	24	26	F900-TG-12.7AF
12.7	G1/4	10	5.5	22	72	50	24	24	26	F900-TG-12.7BF
12.7	G3/8	10	5.5	22	72	50	24	24	32	F900-TG-12.7CF

T型儀錶連管接頭 (Rc螺絲)

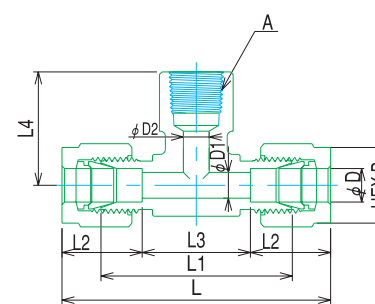

口徑D	A	D1	D2	B	L	L1	L2	L3	L4	型號
3.2	Rc1/8	2.7	7	10	47	34	13	21	20	F900-TG-3.2A
3.2	Rc1/4	2.7	7	10	52	39	13	26	22	F900-TG-3.2B
6.35	Rc1/8	5	7	14	51	37	15	21	20	F900-TG-6.35A
6.35	Rc1/4	5	7	14	58	44	15	28	22	F900-TG-6.35B
6.35	Rc3/8	5	7	14	64	50	15	34	26	F900-TG-6.35C
9.52	Rc1/8	7.5	7	17	60	44	17.5	25	22	F900-TG-9.52A
9.52	Rc1/4	7.5	7.5	17	60	44	17.5	25	22	F900-TG-9.52B
9.52	Rc3/8	7.5	7.5	17	66	50	17.5	31	26	F900-TG-9.52C
12.7	Rc1/8	10	7	22	72	50	24	24	26	F900-TG-12.7A
12.7	Rc1/4	10	10	22	72	50	24	24	26	F900-TG-12.7B
12.7	Rc3/8	10	10	22	72	50	24	24	26	F900-TG-12.7C
19.05	Rc3/8	16	12	29	82	60	25.2	31.6	32	F900-TG-19.05C
19.05	Rc1/2	16	16	29	82	60	25.2	31.6	32	F900-TG-19.05D

T型儀錶連管接頭 (NPT螺絲)

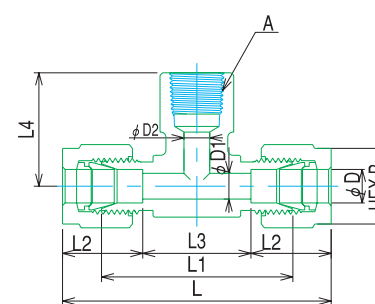

口徑D	A	D1	D2	B	L	L1	L2	L3	L4	型號
3.2	1/8NPT	2.7	7	10	47	34	13	21	20	F900-TG-3.2AN
3.2	1/4NPT	2.7	7	10	52	39	13	26	22	F900-TG-3.2BN
6.35	1/8NPT	5	7	14	51	37	15	21	20	F900-TG-6.35AN
6.35	1/4NPT	5	7	14	58	44	15	28	22	F900-TG-6.35BN
6.35	3/8NPT	5	7	14	64	50	15	34	26	F900-TG-6.35CN
9.52	1/8NPT	7.5	7	17	60	44	17.5	25	22	F900-TG-9.52AN
9.52	1/4NPT	7.5	7.5	17	60	44	17.5	25	22	F900-TG-9.52BN
9.52	3/8NPT	7.5	7.5	17	66	50	17.5	31	26	F900-TG-9.52CN
12.7	1/8NPT	10	7	22	72	50	24	24	26	F900-TG-12.7AN
12.7	1/4NPT	10	10	22	72	50	24	24	26	F900-TG-12.7BN
12.7	3/8NPT	10	10	22	72	50	24	24	26	F900-TG-12.7CN



(單位：mm)

TL儀錶連管接頭 (Rc螺絲)

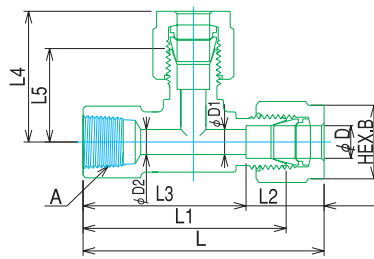

口徑D	A	D1	D2	B	L	L1	L2	L3	L4	L5	型號
3.2	Rc1/8	2.7	7	10	43.5	37	13	30.5	23.5	17	F900-TLG-3.2A
3.2	Rc1/4	2.7	7	10	48	41.5	13	35	26	19.5	F900-TLG-3.2B
6.35	Rc1/8	5	7	14	45.5	38.5	15	30.5	25.5	18.5	F900-TLG-6.35A
6.35	Rc1/4	5	7	14	51	44	15	36	29	22	F900-TLG-6.35B
6.35	Rc3/8	5	7	14	58	51	15	43	32	25	F900-TLG-6.35C
9.52	Rc1/8	7.5	7.5	17	52	44	17.5	34.5	30	22	F900-TLG-9.52A
9.52	Rc1/4	7.5	7.5	17	52	44	17.5	34.5	30	22	F900-TLG-9.52B
9.52	Rc3/8	7.5	7.5	17	59	51	17.5	41.5	33	25	F900-TLG-9.52C
12.7	Rc1/8	10	7	22	62	51	24	38	36	25	F900-TLG-12.7A
12.7	Rc1/4	10	10	22	62	51	24	38	36	25	F900-TLG-12.7B
12.7	Rc3/8	10	10	22	62	51	24	38	36	25	F900-TLG-12.7C
19.05	Rc3/8	16	12	29	82	60	32	25.2	31.6		F900-TLG-19.05C
19.05	Rc1/2	16	16	29	82	60	32	25.2	31.6		F900-TLG-19.05D

TL儀錶連管接頭 (NPT螺絲)

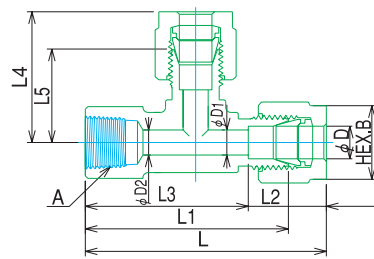

口徑D	A	D1	D2	B	L	L1	L2	L3	L4	L5	型號
3.2	1/8NPT	2.7	7	10	43.5	37	13	30.5	23.5	17	F900-TLG-3.2AN
3.2	1/4NPT	2.7	7	10	48	41.5	13	35	26	19.5	F900-TLG-3.2BN
6.35	1/8NPT	5	7	14	45.5	38.5	15	30.5	25.5	18.5	F900-TLG-6.35AN
6.35	1/4NPT	5	7	14	51	44	15	36	29	22	F900-TLG-6.35BN
6.35	3/8NPT	5	7	14	58	51	15	43	32	25	F900-TLG-6.35CN
9.52	1/8NPT	7.5	7.5	17	52	44	17.5	34.5	30	22	F900-TLG-9.52AN
9.52	1/4NPT	7.5	7.5	17	52	44	17.5	34.5	30	22	F900-TLG-9.52BN
9.52	3/8NPT	7.5	7.5	17	59	51	17.5	41.5	33	25	F900-TLG-9.52CN
12.7	1/8NPT	10	7	22	62	51	24	38	36	25	F900-TLG-12.7AN
12.7	1/4NPT	10	10	22	62	51	24	38	36	25	F900-TLG-12.7BN
12.7	3/8NPT	10	10	22	62	51	24	38	36	25	F900-TLG-12.7CN

TS連管接頭(R螺絲)

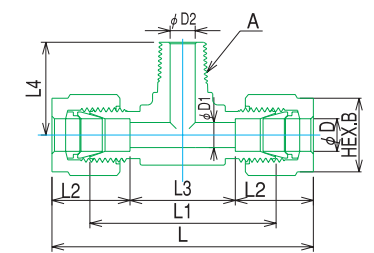

口徑D	A	D1	D2	B	L	L1	L2	L3	L4	型號
3.2	R1/8	2.7	5	10	47	34	13	21	20	F900-TS-3.2A
3.2	R1/4	2.7	5	10	47	34	13	21	22	F900-TS-3.2B
6.35	R1/8	5	5	14	51	37	15	21	20	F900-TS-6.35A
6.35	R1/4	5	5	14	51	37	15	21	22	F900-TS-6.35B
6.35	R3/8	5	5	14	58	44	15	28	25	F900-TS-6.35C
6.35	R1/2	5	5	14	64	50	15	34	32	F900-TS-6.35D
9.52	R1/8	7.5	5	17	60	44	17.5	25	24	F900-TS-9.52A
9.52	R1/4	7.5	7.5	17	60	44	17.5	25	24	F900-TS-9.52B
9.52	R3/8	7.5	7.5	17	60	44	17.5	25	25	F900-TS-9.52C
9.52	R1/2	7.5	7.5	17	66	50	17.5	31	32	F900-TS-9.52D
12.7	R1/8	10	5	22	72	50	24	24	29	F900-TS-12.7A
12.7	R1/4	10	7.5	22	72	50	24	24	29	F900-TS-12.7B
12.7	R3/8	10	10	22	72	50	24	24	29	F900-TS-12.7C
12.7	R1/2	10	10	22	72	50	24	24	32	F900-TS-12.7D

TS連管接頭(NPT螺絲)

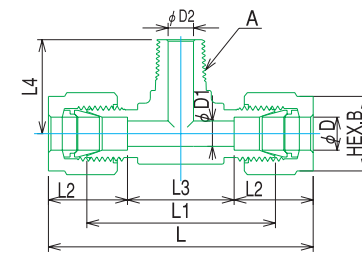

口徑D	A	D1	D2	B	L	L1	L2	L3	L4	型號
3.2	1/8NPT	2.7	5	10	47	34	13	21	20	F900-TS-3.2AN
3.2	1/4NPT	2.7	5	10	47	34	13	21	22	F900-TS-3.2BN
6.35	1/8NPT	5	5	14	51	37	15	21	20	F900-TS-6.35AN
6.35	1/4NPT	5	5	14	51	37	15	21	22	F900-TS-6.35BN
6.35	3/8NPT	5	5	14	58	44	15	28	25	F900-TS-6.35CN
6.35	1/2NPT	5	5	14	64	50	15	34	32	F900-TS-6.35DN
9.52	1/8NPT	7.5	5	17	60	44	17.5	25	24	F900-TS-9.52AN
9.52	1/4NPT	7.5	7.5	17	60	44	17.5	25	24	F900-TS-9.52BN
9.52	3/8NPT	7.5	7.5	17	60	44	17.5	25	25	F900-TS-9.52CN
9.52	1/2NPT	7.5	7.5	17	66	50	17.5	31	32	F900-TS-9.52DN
12.7	1/8NPT	10	5	22	72	50	24	24	29	F900-TS-12.7AN
12.7	1/4NPT	10	7.5	22	72	50	24	24	29	F900-TS-12.7BN
12.7	3/8NPT	10	10	22	72	50	24	24	29	F900-TS-12.7CN
12.7	1/2NPT	10	10	22	72	50	24	24	32	F900-TS-12.7DN

TL連管接頭 (R螺絲)

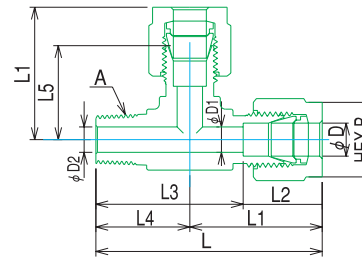

口徑D	A	D1	D2	B	L	L1	L2	L3	L4	L5	型號
3.2	R1/8	2.7	5	10	43.5	23.5	13	30.5	20	17	F900-TL-3.2A
3.2	R1/4	2.7	5	10	45.5	23.5	13	32.5	22	17	F900-TL-3.2B
6.35	R1/8	5	5	14	45.5	25.5	15	30.5	20	18.5	F900-TL-6.35A
6.35	R1/4	5	5	14	47.5	25.5	15	32.5	22	18.5	F900-TL-6.35B
6.35	R3/8	5	5	14	54	29	15	39	25	22	F900-TL-6.35C
6.35	R1/2	5	5	14	64	32	15	49	32	25	F900-TL-6.35D
9.52	R1/8	7.5	5	17	54	30	17.5	36.5	24	22	F900-TL-9.52A
9.52	R1/4	7.5	7.5	17	54	30	17.5	36.5	24	22	F900-TL-9.52B
9.52	R3/8	7.5	7.5	17	55	30	17.5	37.5	25	22	F900-TL-9.52C
9.52	R1/2	7.5	7.5	17	65	33	17.5	47.5	32	25	F900-TL-9.52D
12.7	R1/8	10	5	22	65	36	24	41	29	25	F900-TL-12.7A
12.7	R1/4	10	7.5	22	65	36	24	41	29	25	F900-TL-12.7B
12.7	R3/8	10	10	22	65	36	24	41	29	25	F900-TL-12.7C
12.7	R1/2	10	10	22	68	36	24	44	32	25	F900-TL-12.7D

TL連管接頭 (NPT螺絲)

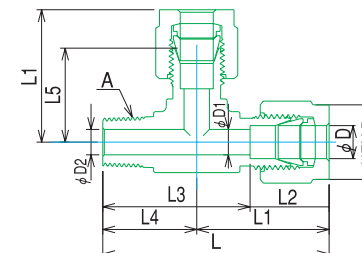

口徑D	A	D1	D2	B	L	L1	L2	L3	L4	L5	型號
3.2	1/8NPT	2.7	5	10	43.5	23.5	13	30.5	20	17	F900-TL-3.2AN
3.2	1/4NPT	2.7	5	10	45.5	23.5	13	32.5	22	17	F900-TL-3.2BN
6.35	1/8NPT	5	5	14	45.5	25.5	15	30.5	20	18.5	F900-TL-6.35AN
6.35	1/4NPT	5	5	14	47.5	25.5	15	32.5	22	18.5	F900-TL-6.35BN
6.35	3/8NPT	5	5	14	54	29	15	39	25	22	F900-TL-6.35CN
6.35	1/2NPT	5	5	14	64	32	15	49	32	25	F900-TL-6.35DN
9.52	1/8NPT	7.5	5	17	54	30	17.5	36.5	24	22	F900-TL-9.52AN
9.52	1/4NPT	7.5	7.5	17	54	30	17.5	36.5	24	22	F900-TL-9.52BN
9.52	3/8NPT	7.5	7.5	17	55	30	17.5	37.5	25	22	F900-TL-9.52CN
9.52	1/2NPT	7.5	7.5	17	65	33	17.5	47.5	32	25	F900-TL-9.52DN
12.7	1/8NPT	10	5	22	65	36	24	41	29	25	F900-TL-12.7AN
12.7	1/4NPT	10	7.5	22	65	36	24	41	29	25	F900-TL-12.7BN
12.7	3/8NPT	10	10	22	65	36	24	41	29	25	F900-TL-12.7CN
12.7	1/2NPT	10	10	22	68	36	24	44	32	25	F900-TL-12.7DN



(單位: mm)

連管接頭管帽

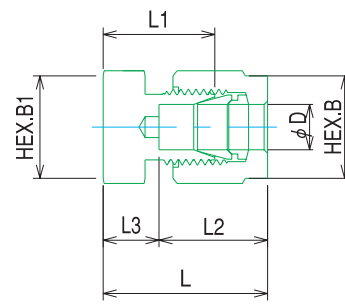

口徑D	B	B1	L	L1	L2	L3	型號
3.2	10	10	20	13.5	13	7	F900-JC-3.2
6.35	14	14	23	16	15	8	F900-JC-6.35
9.52	17	17	26	18	17.5	8.5	F900-JC-9.52
12.7	22	22	31.5	20.5	24	7.5	F900-JC-12.7

連管塞

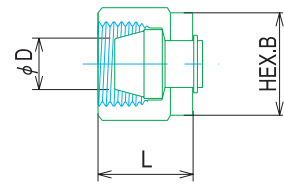

口徑D	B	L	型號
3.2	10	12	F900-JP-3.2
6.35	14	13	F900-JP-6.35
9.52	17	14.5	F900-JP-9.52
12.7	22	18.2	F900-JP-12.7
19.05	29	19	F900-JP-19.05
25.4	38	20.7	F900-JP-25.4

接埠連接器

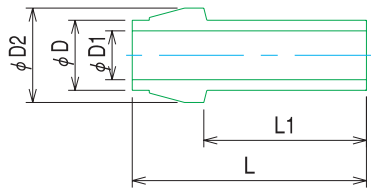

口徑D	D1	D2	L	L1	型號
3.2	1.8	6.2	25	16	F900-PC-3.2
6.35	4.5	9.4	28	19	F900-PC-6.35
9.52	7	12.6	30.5	21.5	F900-PC-9.52
12.7	10	17.4	42	28.5	F900-PC-12.7
19.05	15	23.7	44	30.5	F900-PC-19.05
25.4	21	30	51	35.7	F900-PC-25.4

前環 · 後環

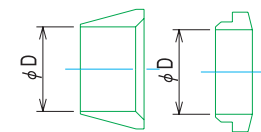

口徑D	型號
3.2	F900-3.2S.R
6.35	F900-6.35S.R
9.52	F900-9.52S.R
12.7	F900-12.7S.R
19.05	F900-19.05S.R
25.4	F900-25.4S.R

(單位: mm)

母螺帽

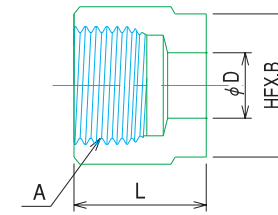

口徑D	A	B	L	型號
3.2	5/16-20UN	10	12	F900-3.2N
6.35	7/16-20UNF	14	13	F900-6.35N
9.52	9/16-20UN	17	14.5	F900-9.52N
12.7	3/4-20UNEF	22	18.2	F900-12.7N
19.05	1-20UNEF	29	19	F900-19.05N
25.4	1-5/16-20UN	38	20.7	F900-25.4N

配管轉接器(R螺絲)

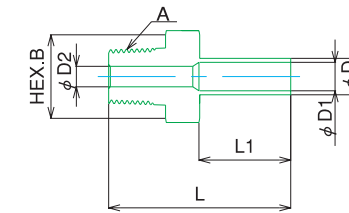

口徑D	A	D1	D2	B	L	L1	型號
3.2	R1/8	1.8	4.5	12	28.5	13.5	F900-AT-3.2A
3.2	R1/4	1.8	4.5	14	31.5	13.5	F900-AT-3.2B
6.35	R1/8	4.5	4.5	12	31	16	F900-AT-6.35A
6.35	R1/4	4.5	4.5	14	35	16	F900-AT-6.35B
6.35	R3/8	4.5	4.5	17	36	16	F900-AT-6.35C
6.35	R1/2	4.5	4.5	22	41	16	F900-AT-6.35D
9.52	R1/8	7	5	12	33	18	F900-AT-9.52A
9.52	R1/4	7	7	14	37	18	F900-AT-9.52B
9.52	R3/8	7	7	17	38	18	F900-AT-9.52C
9.52	R1/2	7	7	22	43	18	F900-AT-9.52D
12.7	R1/8	10	5	14	40.5	24.5	F900-AT-12.7A
12.7	R1/4	10	7.5	14	43.5	24.5	F900-AT-12.7B
12.7	R3/8	10	10	17	44.5	24.5	F900-AT-12.7C
12.7	R1/2	10	10	22	49.5	24.5	F900-AT-12.7D
19.05	R3/8	15	10	22	50	26	F900-AT-19.05C
19.05	R1/2	15	12	22	53	26	F900-AT-19.05D
19.05	R3/4	15	15	29	55	26	F900-AT-19.05E

配管轉接器(NPT螺絲)

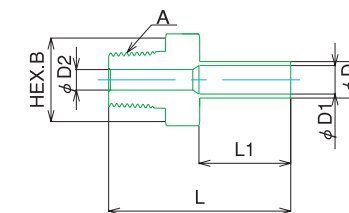

口徑D	A	D1	D2	B	L	L1	型號
3.2	1/8NPT	1.8	4.5	12	28.5	13.5	F900-AT-3.2AN
3.2	1/4NPT	1.8	4.5	14	31.5	13.5	F900-AT-3.2BN
6.35	1/8NPT	4.5	4.5	12	31	16	F900-AT-6.35AN
6.35	1/4NPT	4.5	4.5	14	35	16	F900-AT-6.35BN
6.35	3/8NPT	4.5	4.5	19	36	16	F900-AT-6.35CN
6.35	1/2NPT	4.5	4.5	22	41	16	F900-AT-6.35DN
9.52	1/8NPT	7	5	12	33	18	F900-AT-9.52AN
9.52	1/4NPT	7	7	14	37	18	F900-AT-9.52BN
9.52	3/8NPT	7	7	19	38	18	F900-AT-9.52CN
9.52	1/2NPT	7	7	22	43	18	F900-AT-9.52DN
12.7	1/8NPT	10	5	14	40.5	24.5	F900-AT-12.7AN
12.7	1/4NPT	10	7.5	14	43.5	24.5	F900-AT-12.7BN
12.7	3/8NPT	10	10	19	44.5	24.5	F900-AT-12.7CN
12.7	1/2NPT	10	10	22	49.5	24.5	F900-AT-12.7DN



(單位: mm)

公配管轉接器(G螺絲)

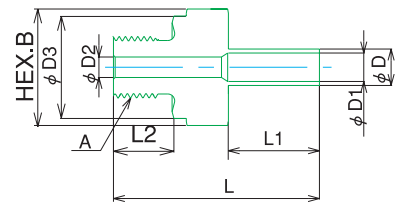

口徑D	A	D1	D2	D3	B	L	L1	L2	型號
3.2	G1/8	1.8	4	13.7	14	28.9	13.5	7.4	F900-AT-3.2AF
3.2	G1/4	1.8	5	18.7	19	34.4	13.5	11	F900-AT-3.2BF
6.35	G1/8	4.5	4	13.7	14	31.4	16	7.4	F900-AT-6.35AF
6.35	G1/4	4.5	5	18.7	19	36.9	16	11	F900-AT-6.35BF
9.52	G1/4	7	5	18.7	19	38.9	18	11	F900-AT-9.52BF
9.52	G3/8	7	8	21.7	22	40.9	18	11.4	F900-AT-9.52CF
9.52	G1/2	7	10	25.7	26	45.5	18	15	F900-AT-9.52DF
12.7	G1/4	10	5	18.7	19	45.4	24.5	11	F900-AT-12.7BF
12.7	G3/8	10	8	21.7	22	47.4	24.5	11.4	F900-AT-12.7CF
12.7	G1/2	10	10	25.7	26	52	24.5	15	F900-AT-12.7DF

配管儀錶轉接器(NPT螺絲)

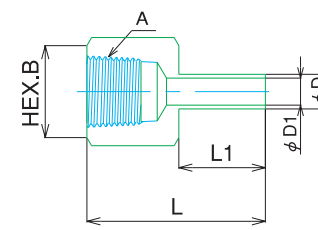

口徑D	A	D1	B	L	L1	型號
3.2	1/8NPT	1.8	14	27.5	13.5	F900-ATG-3.2AN
3.2	1/4NPT	1.8	17	30.5	13.5	F900-ATG-3.2BN
6.35	1/8NPT	4.5	14	30	16	F900-ATG-6.35AN
6.35	1/4NPT	4.5	17	33	16	F900-ATG-6.35BN
6.35	3/8NPT	4.5	21	35	16	F900-ATG-6.35CN
6.35	1/2NPT	4.5	26	39	16	F900-ATG-6.35DN
9.52	1/8NPT	7	14	32	18	F900-ATG-9.52AN
9.52	1/4NPT	7	17	35	18	F900-ATG-9.52BN
9.52	3/8NPT	7	21	37	18	F900-ATG-9.52CN
9.52	1/2NPT	7	26	41	18	F900-ATG-9.52DN
12.7	1/8NPT	7.5	14	38.5	24.5	F900-ATG-12.7AN
12.7	1/4NPT	10	17	41.5	24.5	F900-ATG-12.7BN
12.7	3/8NPT	10	21	43.5	24.5	F900-ATG-12.7CN
12.7	1/2NPT	10	26	47.5	24.5	F900-ATG-12.7DN

(單位: mm)

O型環配管轉接器(UNF螺絲)

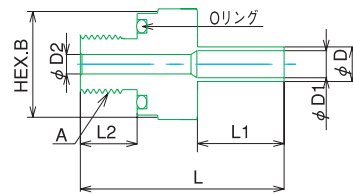

口徑D	A	D1	D2	B	L	L1	L2	O型環尺寸	型號
3.2	5/16-24UNF	1.8	4	14	31	13.5	8.5	P8	F900-AT-3.2×5/16-24-OR
6.35	7/16-20UNF	4.5	4.5	19	36.5	16	10.5	P12.5	F900-AT-6.35×7/16-20-OR
9.52	9/16-18UNF	7	7	26	41	18	12	P18	F900-AT-9.52×9/16-18-OR
12.7	3/4-16UNF	10	10	29	48.5	24.5	12	P21	F900-AT-12.7×3/4-16-OR

配管儀錶轉接器(Rc螺絲)

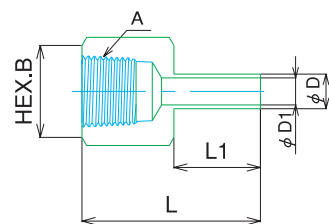

口徑D	A	D1	B	L	L1	型號
3.2	Rc1/8	1.8	14	27.5	13.5	F900-ATG-3.2A
3.2	Rc1/4	1.8	17	30.5	13.5	F900-ATG-3.2B
6.35	Rc1/8	4.5	14	30	16	F900-ATG-6.35A
6.35	Rc1/4	4.5	17	33	16	F900-ATG-6.35B
6.35	Rc3/8	4.5	21	35	16	F900-ATG-6.35C
6.35	Rc1/2	4.5	26	39	16	F900-ATG-6.35D
9.52	Rc1/8	7	14	32	18	F900-ATG-9.52A
9.52	Rc1/4	7	17	35	18	F900-ATG-9.52B
9.52	Rc3/8	7	21	37	18	F900-ATG-9.52C
9.52	Rc1/2	7	26	41	18	F900-ATG-9.52D
12.7	Rc1/8	7.5	14	38.5	24.5	F900-ATG-12.7A
12.7	Rc1/4	10	17	41.5	24.5	F900-ATG-12.7B
12.7	Rc3/8	10	21	43.5	24.5	F900-ATG-12.7C
12.7	Rc1/2	10	26	47.5	24.5	F900-ATG-12.7D



配管技術資料

●1-1 選擇配管之必要性

FINELOK PURE[®] 設計重點是希望經由連接配管後，獲得更卓越的耐壓性、氣密性等性能，故配管的選擇與考量乃是維持 FINELOK PURE[®] 原有信用、安全性之重點工作。為了提昇 FINELOK PURE[®] 信用，乃至為了完成更具高安全性配管連接，施工時敬請務必選用最適當的配管。

●1-2 配管之最小厚度

為了100%發揮 FINELOK PURE[®] 性能，敬請使用下列記載最小口徑管度以上配管。

口徑	最小厚度 (mm)
1/8 OD (3.2)	0.50
1/4 OD (6.35)	0.88
3/8 OD (9.52)	1.00
1/2 OD (12.7)	1.24
3/4 OD (19.05)	1.65
1 OD (25.4)	2.11

(註)特殊情況必須使用未達最小厚度的配管時，敬請務必與本公司洽商。

●1-3 配管硬度

FINELOK PURE[®] 業依指定使用Hv200以下配管硬度。即使Hv250配管硬度雖經確認沒有任何問題，但為了提昇「配管彎曲加工作業效能」及降低「加工硬化導致應力腐蝕龜裂」等，本公司依然會加以嚴格管制。另外經光澤熱處理(BRIGHT ANNEAL)的配管硬度則為Hv160左右。

●1-4 配管彎曲加工尺寸表

FINELOK PURE[®] 基本上必須在配管端頂住本體肩部(BODY SHOULDER)狀態下，栓緊，故必須具備最低限度的「直管部位」。配管彎曲加工時，請參考下表中記載數值，請儘量設計較長的直管部位。

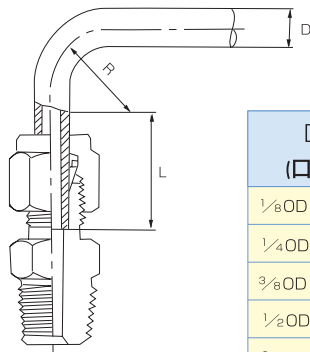

D (口徑)	L		R (最小尺寸)
	L1	L2	
1/8 OD (3.2)	19	15	9.53
1/4 OD (6.35)	21	17	14.28
3/8 OD (9.52)	24	19.5	23.81
1/2 OD (12.7)	31	26	38.1
3/4 OD (19.05)	33	27	76.2
1 OD (25.4)	38	33	88.9

L1:配管直管部位最小尺寸。
L2:配管直管部位最小尺寸，僅限於必要場合使用。

●1-5 SUS304&316配管之最高使用壓力

配管口徑厚度 (mm)	材質	[MPa]					
		0.72	0.89	1	1.24	1.65	2.11
1/8 OD (3.2)	SUS304	45.4(33.2)	53.7(39.3)	58.3(42.7)	—	—	—
	SUS316	45.4(35.4)	53.7(41.8)	58.3(45.3)	—	—	—
1/4 OD (6.35)	SUS304	—	40.5(29.7)	46.3(33.8)	59.4(43.5)	—	—
	SUS316	—	40.5(31.5)	46.3(36.0)	59.4(46.3)	—	—
3/8 OD (9.52)	SUS304	—	—	29.4(21.6)	37.3(27.4)	51.7(37.9)	—
	SUS316	—	—	29.4(22.8)	37.3(29.0)	51.7(40.2)	—
1/2 OD (12.7)	SUS304	—	—	—	27.2(19.9)	37.2(27.3)	—
	SUS316	—	—	—	27.2(21.2)	37.2(28.9)	—
3/4 OD (19.05)	SUS304	—	—	—	—	21.4(17.1)	—
	SUS316	—	—	—	—	21.4(17.7)	—
1 OD (25.4)	SUS304	—	—	—	—	—	20.3(16.2)
	SUS316	—	—	—	—	—	20.3(16.9)

(註)以上數值為溫度40°C之最高使用壓力。(I)數值為150°C之最高使用壓力。

●1-6 富士金品牌配管之規格

- (1)標準材質：JIS B3459 SUS304、SUS316。
- (2)經光澤熱處理(BRIGHT ANNEAL)且無接縫的配管，硬度在Hv180以下。
- (3)配管內外側皆經過特殊加工，表面呈現光澤狀態，特別是配管內面粗糙度可達4S以下，(口徑1/4OD以上)。
- (4)配管彎曲：每1m最大限度為1mm。
- (5)標準製作尺寸及尺寸公差。

口徑	尺寸公差			
	外徑	厚度	圓潤度	長度
1/8 OD (3.2) × 0.72t	+0.05 0	±0.05	0.03	+5 0
1/4 OD (6.35) × 0.89t	+0.05 0	±0.05	0.03	+5 0
1/4 OD (6.35) × 1t	+0.05 0	±0.05	0.03	+5 0
3/8 OD (9.52) × 1t	+0.05 0	±0.05	0.03	+5 0
1/2 OD (12.7) × 1.24t	+0.05 0	±0.05	0.03	+5 0
3/4 OD (19.05) × 1.65t	+0.07 0	±0.16	0.03	+5 0
1 OD (25.4) × 2.11t	±0.3	±0.2	—(未測定)	+5 0

- (6)配管標準長度：目前庫存有2公尺、4公尺規格。其他尺寸或L材等其他材質等，敬請與本公司洽商。

使用手冊

●2-1 配管施工前

- 1.使用經奧氏體(AUSTENITE)系不鏽鋼，無接縫，經光澤熱處理，外徑精確度為±0.05mm以內，故請使用硬度為Hv200以下之配管。
- 2.配管厚度，請參考本型錄「配管技術資料」。
- 3.使用配管某端起30mm以內，經目測未發現任何「縱向異常瑕疵」的配管。又，發現異物附著時去除異物。
- 4.安裝接頭前，依規定長度切割配管。
- 5.請利用「配管截斷器(TUBE CUTTER)」切割配管。特殊情況必須使用其他「切割器」時，必須呈直角狀態切割，並利用銼刀，呈45度角，由外往內，仔細地削除表面上不平整狀態。

●2-2 緊栓要領

①		確認接頭零件是否確實按照照片中的順序正確地安裝。
②		將配管端完全插入本體肩部(BODY SHOULDER)，接著利用手指將母螺帽旋轉到底後，在本體與母螺帽連接處畫上適當的符號。以此符號為零點。
③		從零點的位置開始，利用扳手將母螺帽旋轉1 1/4圈。至此完成所有栓緊步驟。

小口徑接頭及連管塞、接埠連接器緊栓要領

- 1.3.2(1/8OD)以下尺寸：利用手指栓上螺絲，利用扳手旋轉3/4圈，旋緊母螺帽。至此完成所有栓緊步驟。
- 2.連管塞(F900-JP式)及接埠連接器(F900-PC式)之加工套筒方向與尺寸無關，栓緊後請利用扳手旋轉1/4圈，栓緊母螺帽。(接埠連接器之加工配管方面之緊栓要領與一般配管一樣)，至此完成所有栓緊步驟。

●2-3 緊栓施工時之注意事項：

- 1.栓緊時請使用符合「接頭對邊」之扳手。
- 2.栓緊接頭時，請務必利用扳手等確實固定本體後栓緊母螺帽。在母螺帽固定的狀態下，請勿旋轉本體。
- 3.栓緊接頭後，欲改變接頭方向(安裝角度)時，請務必暫時鬆開接頭後再變換方向。
- 4.栓緊接頭之際，配管與接頭務必呈一直線後進行對芯。
- 5.接頭零件鬆脫時，請勿直接使用，請務必確認該零件是否刮傷或附著垃圾後才能使用。
- 6.栓緊T型彎管接頭時，請儘量使用T型扳手。
- 7.於配管施工困難度較高場所進行配管施工時，請事先備妥接頭、暫時栓緊，以避免栓緊度不足而發生問題。

●2-4 拆卸後重新安裝要領

①		安裝前，請先確認本體錐形面、前套圈部位是否有異物附著。
②		將前套圈完全插入本體、錐形部位，利用手指，確實栓緊母螺帽。
③		其次，利用扳手，旋轉母螺帽約1/4圈，栓緊後完成栓緊步驟。(註)栓緊後狀態：位於原來位置或稍微偏向前方位置。

●2-5 特殊工具

1.T型扳手 (PAT.)(PAT.P.)



使用一般扳手無法支撐本體，T型扳手是安裝T型或彎管接頭等時的支撐工具。T型扳手除了具備支撐本體功能外，更具備固定功能，故絕對有助於作業之進行。(富士金發明)

2.特殊扳手



這是一款解決市售扳手費力、手痛、頭部太厚重等問題，最適合用於安裝接頭的專用扳手。(富士金發明)

3.預備栓緊工具



這是一款可事先在良好場所預作準備，事先組裝套圈，對付天花板配管、地板下配管、嵌入式裝置內配管等，位於以正規安裝方式難以克服場所等接頭時的絕佳工具。(富士金發明)

4.配管截斷器(PAT.P.)



使用後切口完整，配管上不會留下夾鉗夾痕，故是一款最適合安裝無縫接頭時使用的富士金製配管截斷器。(富士金技術指導產品)

5.活動扳手



扳頭厚度相當薄，特殊握柄好握、好拿。富士金精心推薦。(日本理器(股)製造)

●2-6 關於蝕刻技術(ETCHING)

接頭經蝕刻技術處理後，使用前請務必與本公司洽商。蝕刻處理不當，將嚴重影響表面精密度，故請務必謹慎。

Fujikin®



Fujikin® Carp® Group

URL <http://www.fujikin.co.jp/> E-mail info@fujikin.co.jp



The Year 2005
The 1st Monozukuri (manufacturing)
Nippon Grand Awards
: Excellence Prize